

MODEL 2520

DELUXE CONTROL/COMMUNICATOR

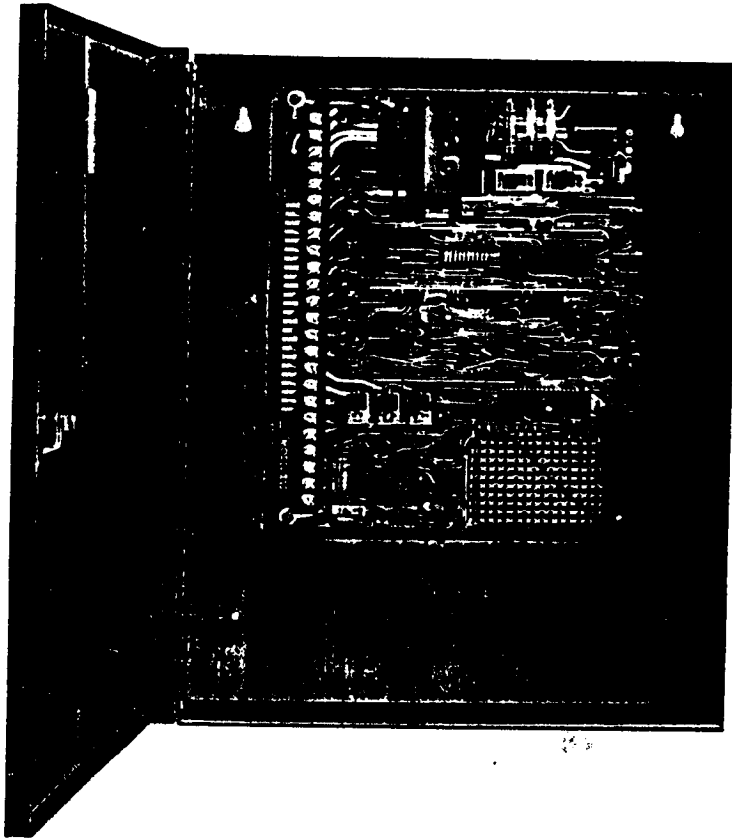

INSTALLATION MANUAL

SILENT KNIGHT

A DIVISION OF WAYCROSSE, INC.



SECURITY SYSTEMS

1700 Freeway Boulevard North, Minneapolis, MN 55430

612/566-0510

INDEX 2520

CONTROL PANEL DESCRIPTION

1) Power Requirements	1
2) "Monitor" Light	2
3) "Alert Silenced" Light	2
4) Fire Reset/Test Switch	
a) Description	2
b) Testing	27
5) Trouble/Alert Speaker Switch	2
6) Fuses (F1-F2-F3)	2
7) Option Switches	3-4
8) Reset Switch	3

DIGITAL DIALER DESCRIPTION

1) Operation	4-5
2) Reporting Codes	5
3) Options	6
4) Programming	6-7
5) FCC Information	7
6) Wiring	8-31
7) Testing	26

MODEL 6812 STANDBY BATTERY

1) Description	8
2) Load	8
3) Expected Hours of Standby	9

MODEL 7890 LIGHTNING KIT 9-15

MODEL 7331 DIGITAL KEY

1) Switch Options	4-9
2) Programming	9-10
3) "Ready" Light	10
4) System "Armed" Light	10
5) Wiring	15-16-31
6) Testing	17

MODEL 7230 MECHANICAL KEY

1) Switch Options	10
2) "Ready" Light	10
3) System "Armed" Light	10

INPUT/OUTPUT CONNECTIONS

1) Intrusion Inputs	
a) Description	10-11
b) Wiring	17-18-29-30-31
c) Testing	18-19-20-21
2) Fire Input	
a) Description	11-21-22
b) Wiring	22-23-30-31
c) Testing	23-24
3) Emergency Input	
a) Description	11
b) Wiring	24-25-30-31
c) Testing	25
4) Internal Speakers	12
5) External Speakers or Bell	12
6) System "Armed" Light	12
7) Ready Light	12

INSTALLATION PROCEDURES

1) Pre-Installation Set-Up	12-13
2) Location Selection	14
3) Mounting	14
4) Transformer	14
5) Jumpers	15
6) Model 7890	15
7) Battery	15
8) End-Of-Line Resistor	15

ATTEMPT-TO-RESET/SHUTDOWN

<u>TEST</u>	27-28
-------------	-------

TEST FREQUENCY

2520 INSTALLATION MANUAL

INTRODUCTION

The Model 2520 is a complete three channel alarm control panel combined with a Digital Dialer which will automatically dial up a central message receiving station and report the alarm conditions and the clients account number.

In addition to reporting the three alarm conditions, The Model 2520 will also report a "Low Battery" condition (self-initiating), "Trouble" in the Fire Circuit, a "Test", "Opening/Closing" and "Restore-to-Normal".

Some of the "Built-in" features of the 2520 include:

- Customer Programmable -- In Seconds
- Siren Driver
- Battery Charger
- Exit/Entrance Delay
- Entrance Warning
- Attempt-To-Reset and Siren Shutdown
- Touch Pad Annunciator
- Digital or Mechanical Key for Arming and Disarming
- Selectable Digital Dialer Reporting Format
- 24 Hour Tamper Circuit
- Line Seizure Relay

Power Requirements

The Model 2520 is powered from a U.L. Listed Class II, 16.5 volt, 40 VA transformer that plugs directly into a conventional 120 volt AC, 60Hz wall outlet. This transformer provides up to 2.5 amps of current at 12 volts DC. That power is sufficient for the 2520, its accessories and the charging current for one Model 6812 battery.

Figure 1 shows a representation of the printed circuit board of the 2520. This printed circuit board contains the switches, fuses and indicators needed to set-up, monitor, reset and protect the system.

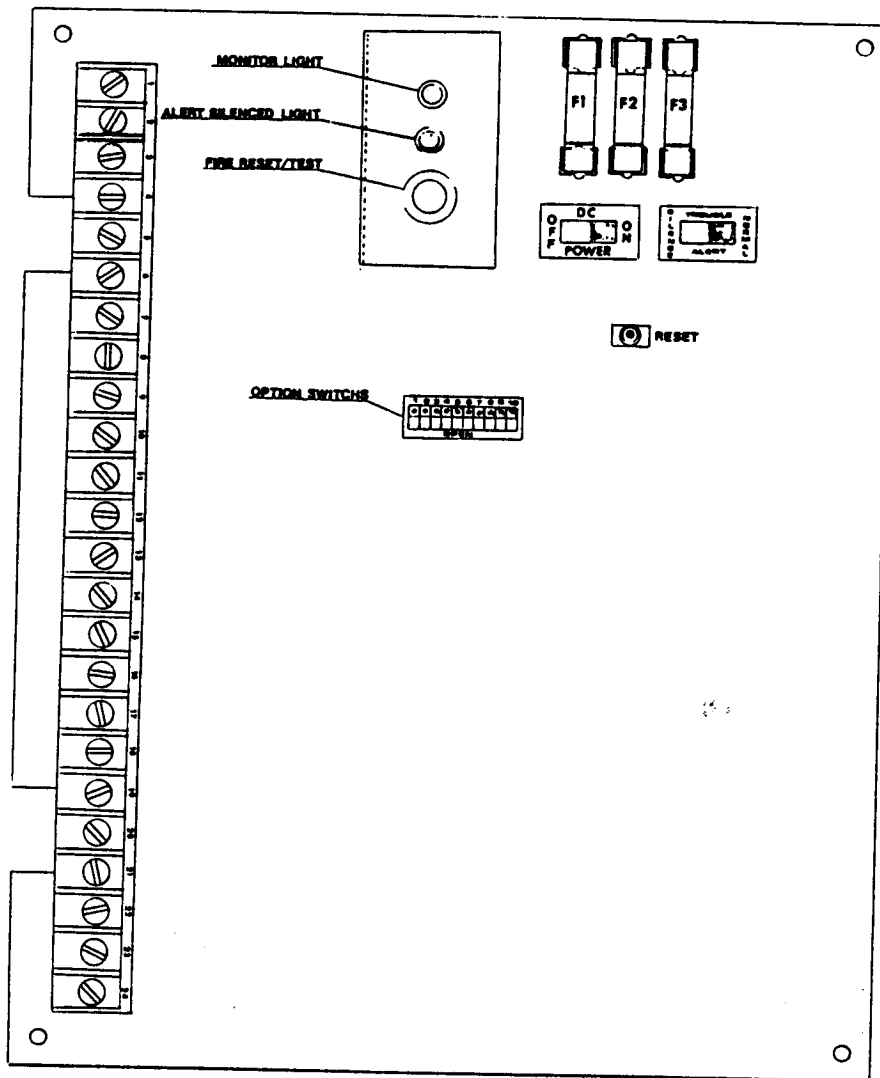

Figure 1.

Monitor Light

The monitor light is normally ON and will remain so unless one or more of the following occurs:

- AC power failure (light OFF).
- DC power failure (light OFF).
- Fire loop "Trouble" (light OFF).

Alert Silenced Light

This light is used to indicate the status of the Trouble/Alert switch. If the Trouble/Alert switch is in the "Normal" position the Alert Silenced Light will be OFF. If the Trouble/Alert switch is in the Silenced position the Alert Silenced Light will be ON.

Fire Reset/Test Switch

This is used to perform the following functions:

- Reset Smoke Detectors
- Reset the Fire Circuit
- Test the Fire Circuit
- Test the Battery
- Test the Digital Dialer

Fuse F1

This fuse provides over-current protection for the smoke detectors, accessories, and alarm loops (2.5 amp).

Fuse F2

This fuse provides over-current protection for the external speaker output (3 amp).

Fuse F3

This fuse provides over-current protection for all light and indicator outputs and the internal speaker outputs (2.5 amp).

Trouble/Alert Speaker Switch

This switch is used to silence the "Trouble" alert tone which will sound if the Fire loop becomes defective. Moving the switch to the Silenced position, silences the "Trouble" alert tone and turns ON the Alert Silenced light. NOTE: When this switch is in the Silenced position, the entrance alert and touch pad annunciator will also be silenced.

Reset Switch

The primary function of the Reset Switch is to erase a previously entered "Arm" and "Disarm" code so that a new set of codes may be entered. To program a new "Arm" and "Disarm" code, proceed as follows:

1. Momentarily depress the Reset switch.
2. Go to the nearest Model 7331 (the "Ready" light should be blinking).
3. Depress the digit desired for "Arming" (press once only).
4. Depress, in order, the four digits to be used for "Disarming".
5. The "Arm" and "Disarm" codes are now entered and the "Ready" light should be steady.

OPTION SWITCHES 1 THROUGH 10

The modes of operation in which the Model 2520 can be configured to operate are many and varied. Each switch and the mode of operation it provides are described in the following paragraphs. NOTE: When the rocker of each individual switch is depressed in the direction of the word OPEN the switch will be open. In the opposite direction it will be closed.

Switch (1) Reset/Shutdown (All Channels) Switch (4) Reset/Shutdown (Fire Channel)

The reset and shutdown options are integrated and cannot be controlled separately. This means that you cannot select just reset or just shutdown, if you select one you are selecting both. Switch (1) is used to select reset/shutdown for all channels and Switch(4) is used to control reset/shutdown for the Fire channel. The three modes in which the 2520 may be configured for reset/shutdown are stated in the following:

All channels reset and shutdown:

Switch (1) OPEN, Switch (4) OPEN

All channels except Fire reset and shutdown:

Switch (1) OPEN, Switch (4) CLOSED

No channels reset or shutdown:

Switch (1) CLOSED, Switch (4) CLOSED

Switch (2) and (3) Exit/Entrance Delay

There are four times available for the Exit/Entrance Delay which are selected using combinations of Switches (2) and (3). Position these switches for the different times as stated in the following:

- 15 seconds = Switch (2) OPEN, Switch (3) OPEN
- 30 seconds = Switch (2) CLOSED, Switch (3) OPEN
- 60 seconds = Switch (2) OPEN, Switch (3) CLOSED
- 120 seconds = Switch (2) CLOSED, Switch (3) CLOSED

Switch (5) Opening/Closing Reporting

If you wish to report to the Central Station whenever the system is "Armed" or "Disarmed" (opening/closing) place Switch (5) in the OPEN position. If you do not want these reports, place Switch (5) in the CLOSED position.

NOTE: The Model 2520 will report a code 9 for "opening" (Disarming) code 4 for "closing" (Arming). No other steps need be taken for opening/closing, it is all automatic.

Switch (6) and (9) Digital or Mechanical Key

For Digital Key, Option Switch (6) must be CLOSED and Switch (9) must be OPEN. To use Mechanical Key, Switch (6) must be OPEN and Switch (9) must be CLOSED.

Switch (7) Silent Emergency Alarm

If it is desired to have the Emergency channel silent (no audible alarm), move Switch (7) to the CLOSED position.

Switch (8) Reset/Shutdown Time

Switch (8) is used to determine the amount of time the Model 2520 will be in alarm before it will attempt to reset or, if it cannot be reset, shutdown. With Switch (8) in the OPEN position the reset/shutdown time will be 5 minutes, if in the CLOSED position, the reset/shutdown time will be 15 minutes.

Switch (9) (See Switch (6) above)

Switch (10) External Speaker or Bell

If external speakers are to be used, place Switch (10) in the OPEN position. If an external bell is to be used, place Switch (10) in the CLOSED position. CAUTION: BE SURE SWITCH (10) IS NOT IN CLOSED POSITION IF SPEAKERS ARE CONNECTED. NOTE: If a bell is used, a .22 micro-farad capacitor must be connected across the bell contacts to suppress the contact sparking (12 VDC bell only!).

DIGITAL DIALER

Operation

When activated, the Dialer will dial the telephone number of the alarm Receiver. When the Receiver has answered the call, the Dialer will transmit a three (3) digit location code (account number) and a one (1) digit alarm code. The combination of the three (3) digit account number and one (1) digit alarm code is called a "code group".

The dialing and data transmission occur in the following sequence:

1. Channel input activation.
2. The Dialer seizes the telephone line and listens (checks) for dial tone.
3. Upon detection of dial tone, the Dialer, will dial. If dial tone is not present the Dialer will begin dialing after 24 seconds. During this time it will have attempted to clear the telephone line connection (anti-jam) by performing an on-line/off-line operation.
4. Acknowledgment is received indicating that the alarm Receiver has answered the call.
5. Data is transmitted.
6. "Kiss-off" signal is received, indicating that the alarm Receiver has decoded, compared and displayed two (2) identical "code groups".
7. If more than one alarm input is active, the next alarm "code group" will be transmitted. This will continue until all the alarms have been reported and "Kissed-off".
8. Final "Kiss-off" after all alarms are reported causes the Dialer to hang-up (shut-down).

Reporting

The Dialer will report either the Silent Knight/Ademco format or the Sescoa/Franklin/DCI format.

The Alarm codes transmitted by the Dailer are as follows:

	<u>Silent Knight/ Ademco Format</u>	<u>Sescoa/Franklin/ DCI Format</u>
Channel 1 (Intrusion)	Code 1	Code 3
Channel 2 (Fire)	Code 2	Code 1
Channel 3 (Emergency)	Code 3	Code 2
CLOSING	Code 4	Code 6
Low Battery	Code 8	Code 8
"Trouble" in the Fire loop	Code 8	Code 8
Restore-to-Normal	Code 7	Code 7
Cancel Message, Abort or Test	Code 9	Code 9
OPENING	Code 9	Code 9

Options

The Dialer has two jumper wires which determine the data transmission format and one jumper wire for "Restore-to-Normal" reporting. Selection of these options is as follows:

Jumper (1)	No "Restore-to-Normal" "Restore-to-Normal"	IN OUT (Cut)
Jumpers (2) and (3)	Silent Knight/Ademco Format Sescoa/Franklin/DCI Format	BOTH IN BOTH OUT (Cut)

PROGRAMMING THE DIGITAL DIALER

The Dialer can be programmed to dial as many as eleven (11) digits or as few as three (3) digits. Programming is as follows:

The central station telephone number and the client's account number are selected in the columns A through K and X through Z. If the usual 7 digit telephone number is used, it must be programmed in columns E through K. The account number is always placed in columns X, Y and Z.

	A	B	C	D	E	F	G	H	I	J	K	X	Y	Z
8	●	●	●	●	○	○	○	○	●	○	●	○	○	○
1	○	○	○	○	○	○	○	○	○	○	○	○	○	○
2	○	○	○	○	○	●	○	○	○	○	○	○	○	○
3	○	○	○	○	○	○	●	○	○	○	○	○	○	○
4	○	○	○	○	○	○	○	●	○	○	○	○	○	○
5	○	○	○	○	○	○	○	○	○	○	○	○	●	○
6	○	○	○	○	○	○	○	○	○	○	●	○	○	○
7	○	○	○	○	○	○	○	○	○	○	○	○	○	●
8	○	○	○	○	○	○	○	○	○	○	○	○	○	○
9	○	○	○	○	○	○	○	○	○	○	○	○	○	○
0	○	○	○	○	○	○	○	○	○	○	○	○	○	○

EXAMPLE: 823-4161, Act. 577

If a telephone number containing more than 7 digits is used, the first digit must always go in column A. The last 7 digits go in columns E through K.

	A	B	C	D	E	F	G	H	I	J	K	X	Y	Z
S	○	●	○	○	○	○	○	○	○	○	○	○	○	○
1	○	○	○	●	○	○	○	○	○	○	○	○	○	○
2	○	○	○	○	○	○	○	○	○	○	○	○	○	○
3	○	○	○	○	○	○	○	○	○	○	○	○	○	○
4	○	○	○	○	○	○	○	○	○	○	○	○	○	○
5	○	○	○	○	○	○	○	○	○	○	○	○	○	○
6	○	○	○	○	○	○	○	○	○	○	○	○	○	○
7	○	○	○	○	○	○	○	○	○	○	○	○	○	○
8	○	○	○	○	○	○	○	○	○	○	○	○	○	○
9	○	○	○	○	○	○	○	○	○	○	○	○	○	○
0	○	○	○	○	○	○	○	○	○	○	○	○	○	○

EXAMPLE: 91-722-9415, Act. 257

Digital Dialer Telephone Line Connection

Before connecting this device the telephone company must be notified and provided with the following information:

- a) Manufacturer (Silent Knight)
- b) Model number -- 2520
- c) F. C. C. registration number
- d) Ringer equivalence -- 0.0B
- e) Type of jack (to be installed by the telephone company) RJ31X

Note: The telephone company must also be notified if this device is permanently disconnected!

This device may not be directly connected to coin telephone or party line services.

The telephone company, under certain circumstances, may temporarily discontinue service and/or make changes in its facilities and services which may affect the operation of this device; however, the telephone company is required to give adequate notice in writing of such changes or interruptions.

This device cannot be adjusted or repaired in the field; in case of trouble with the device notify the installing company or return to:

Silent Knight Security Systems
 1700 Freeway Boulevard North
 Minneapolis, Minnesota 55430

Figure 2 shows telephone line connection between the 2520 and the RJ31X via the Model 7860 Connector Cord.

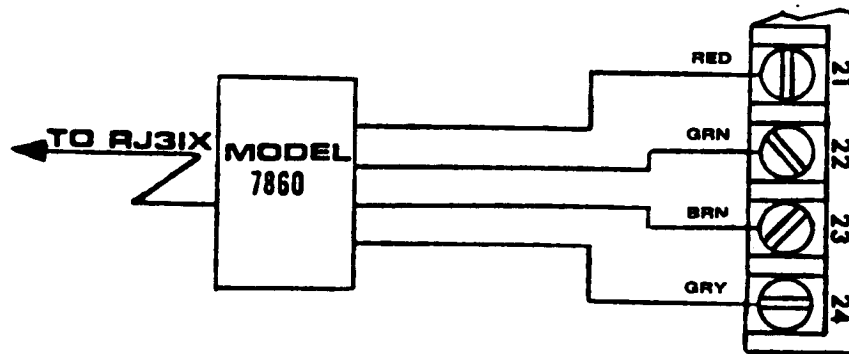

FIGURE 2

Model 6812 Standby Battery

The Model 6812, rechargeable battery is a sealed, electrolyte battery. Maximum charging rate of a fully discharged battery is 700 ma. Nominal trickle charge current is 5 ma. One set of battery cables is attached to each 2520 P. C. Board for connection of the 6812 battery.

CAUTION: Careful observation of polarity is important. The red wire go to positive (+); black wire to negative (-). Connecting these wires in the reverse will result in damage to the 2520.

The current drain for each of the remote modules and accessories which require standby power from the 6812 battery is shown in Table 1.

TABLE 1

<u>Model</u>	<u>Current (MA.)</u>
2520	75
7331	42
7230	42
7610	5

To determine the current load of a 2520 system, add all the current drains of all the remote modules as shown in Table 1. The standby time can then be calculated from Figure 3 which shows the expected hours of standby for various current loads using one (1) 4 amp hour 12 volt battery (Model 6812).

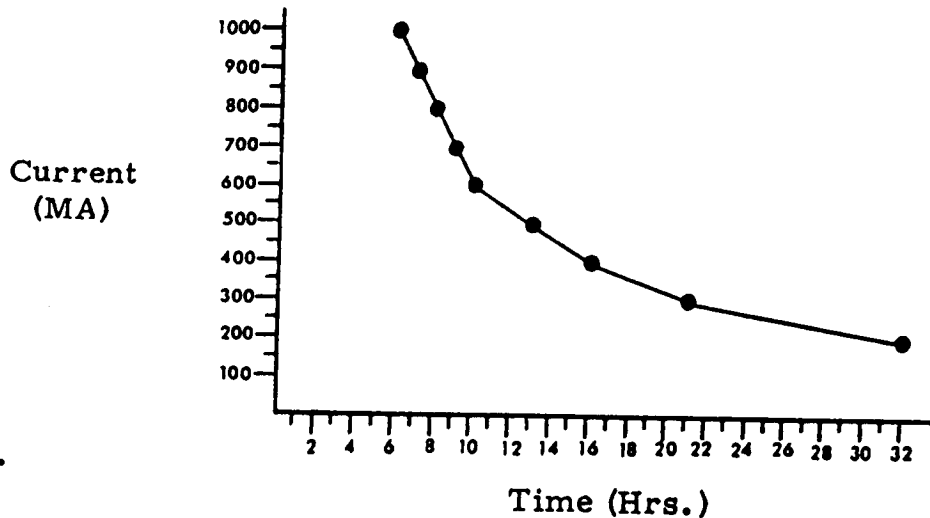

Figure 3.

Model 7890 Lightning Kit

In areas where transient energy and lightning damage is likely, it is essential that the 7890 Lightning Kit be used in the AC/transformer input circuit. Instructions for use and connections are provided with the 7890.

DIGITAL KEY OPERATION (Model 7331)

Switch Options

Switch (6) CLOSED; Switch (9) OPEN. (See page 4.)

Programming

Check that the loop jumpers and 15K resistor are in place.

Switch the DC power switch "On". Ready light on 7331 begins blinking.

You now have approximately one minute to program the Arming/Disarming codes. If you do not enter these codes, the 2520 will automatically program itself to a default code of a digit (5) for arming and digits 1-2-3-4 for disarming. The 2520 will also attempt to Arm itself at this time. If it cannot Arm because an input is active it will immediately go into an Intrusion alarm. To program the Arm and Disarm codes proceed as follows:

- a. Go to the 7331 and press the digit desired for Arming (press once only). Each time a digit is pressed the speaker will emit a momentary tone.

NOTE: The Arming digit may be used in the Disarm code, but not twice in sequence.

- b. Press, in order, the four digits to be used for Disarming. Ready light stops blinking. CODES are entered.

Ready Light

The "Ready" light will be lit unless one or more of the following occur:

1. Sensor (Sensors) in the Exit/Entrance loop is active (light OFF).
2. Sensor (Sensors) in the Instant loop is active (light OFF).
3. The System Armed Light is lit (light OFF).
4. The Digital Dialer is reporting (light BLINKING).
5. The Arm/Disarm codes have not been entered (light BLINKING).

System Armed Light

The System Armed light will light when the "Arm" code is entered (provided the Ready light is lit) and will turn off when the "Disarm" code is entered. When the System Armed light is lit it indicates that the Exit/Entrance loop and Instant loop are active and that a violation of any of these loops will cause an "Intrusion" alarm. NOTE: If the System Armed light is lit and an "Intrusion" alarm occurs the System Armed light will begin blinking and remain so until a "Disarm" code is entered -- even if a reset or shutdown has occurred.

MECHANICAL KEY OPERATION (Model 7230)

Switch Options

Switch (6) OPEN; Switch (9) CLOSED. (See page 4.)

Ready Light

The "Ready" light for Mechanical Key, is the Green light on the 7230. See description for "Digital Key Ready Light" (above).

System Armed Light

The System "Armed" light (Red light on 7230) will change state each time a momentary closure is made between terminals 14 and 4 of the 2520. However, the System "Armed" light will not light if the "Ready" light is not lit.

GENERAL SYSTEM DESCRIPTION (Inputs)

Intrusion Inputs (Channel 1)

The Intrusion channel receives inputs from three circuits: The Instant loop, the Exit/Entrance loop and the Panic/Tamper loop. The following paragraphs describe these inputs.

Instant Loop Input (See Figure 4)

The instant loop accepts either normally-open and/or normally-closed sensors as input devices. The Instant loop is not a continuously active 24-hour circuit. The client arms or disarms this circuit at will.

Activation of an instant loop input sensor will not cause an alarm condition unless the instant loop is armed. Conversely, one cannot arm the system unless the sensors are in their armed positions.

Exit/Entrance Loop Input (See Figure 5)

The exit/entrance loop accepts either normally-open and/or normally-closed sensors as input devices. This loop is not active 24-hours a day, but is armed or disarmed whenever the Intrusion circuit is armed or disarmed. Conversely, one cannot arm the system unless the exit/entrance sensors are in their armed positions.

The exit/entrance loop contains the built-in alarm delay that allows clients a brief time to enter or exit the building without setting-off an alarm. For example, to exit the building, the client arms the system and then has either 15, 30, 60 or 120 seconds to close the exit door behind him as he leaves (refer to switch options (2) and (3), page 3, for delay time selection). If the delay time expires before the exit door is closed, the Intrusion alarm sounds.

Panic/Tamper Loop Input (See Figure 6)

The Panic/Tamper input sensors can be either normally-open or normally-closed sensors but not a combination of both. The Panic/Tamper input is active 24-hours a day.

Fire Input (Channel 2) (See Figure 7)

The Fire channel accepts input on a 24-hour basis to give early fire warning. This channel is fully supervised and an alarm will automatically sound a warning if a wire in the loop is cut, breaks or is shorted to the system ground. The Fire channel accepts normally-open heat and/or smoke detectors as input devices. This channel is a latching circuit and stays active once activated by a momentary closure of an input device.

Emergency Input (Channel 3) (See Figure 8)

The Emergency channel input is also active on a 24-hour basis, and is a latching circuit. The input devices on this channel are normally-open or normally-closed but not a combination of both. Typical use of the Emergency channel is to summon immediate medical attention, or to call help in some other emergency.

GENERAL SYSTEM DESCRIPTION (Outputs)

The following paragraphs describe the alarm outputs and the power supplied to each device in the circuit. The output circuitry is current-limited and fused to prevent disabling of the system by shorting of the external wiring.

The 2520 generates three distinct alarm tones. One for "Intrusion", one for "Fire" and one for "Emergency".

Internal Speakers plus Alert (Terminal 16)

The Internal speaker output generates a pulsed 12 VDC output for driving the internal speakers such as is on the Model 7331. This output also generates the entrance alert tone the fire "Trouble" tone and the Touch Pad Annunciator tone. (The maximum current available is 1.5 amps.)

External Speaker or Bell (Terminals 3 and 17)

The external speaker output generates the alarm tones (pulsed 24 volts DC) for use with a speaker or, if a bell is used, a steady or switched 24 volts DC (depending on which channel is in alarm). If a bell is used in the system, use only a 12 volt DC unit rated at .35 amps or less. Connect a .22 micro-farad capacitor across the bell contacts. The maximum current available is 1.5 amps.

System "Armed" Light Output (Terminal 19)

The system "Armed" output will provide a 12 VDC output at .25 amps whenever the Intrusion channel is "Armed", either by the Model 7331 or 7230. This output will pulse if "Armed" and the Intrusion channel is violated and remain pulsing until the system is disarmed.

Ready Light Output (Terminal 20)

The Ready light output will provide a 12 VDC output at .25 amps whenever the two loops to the Intrusion channel are in their normal (not active) state. If using the Digital Key, this output will be pulsing whenever the Model 2520 has not been programmed for the "Arming" and "Disarming" codes. In addition, this output will be pulsing if the Digital Dialer is reporting to the central message receiving center and will continue to pulse until the message is received and "Kissed-off" by the receiver.

MODEL 2520 INSTALLATION PROCEDURES

Installation of the 2520 usually proceeds in two steps: (1) pre-installation set-up of the 2520 Control Panel, and (2) field wiring of the modules and accessories to the 2520 at the installation site.

Pre-Installation Set-Up

Pre-installation set-up is usually done in the shop before going to the site. Pre-installation set-up includes the following steps:

1. Unpacking of the 2520 components and the careful checking of them for damage. NOTE: Damage must be reported within 10 days to the carrier that delivered the system. Silent Knight is not responsible for damage that occurs in shipment.
2. Selection of the Option switches 1 through 10 (see the description of option switches located on Page 3 of this manual).
3. Optional shop-test of the 2520 Control Panel.

CAUTION: The printed circuit board of the 2520 contains MOS microcircuit components that are subject to damage by electrostatic charges. The enclosure of the 2520 and the protective wiring circuits protect these circuits in normal operation. But, when the circuit board is being programmed for option selection, care must be taken not to touch the circuit board without touching a hand, or a metal tool, to the ground wire of the 2520. This removes any charge that may have accumulated from walking across a carpet, etc.

NOTE: All cable used to field-wire the remote modules, unless otherwise noted, is to be at least 22 gauge, jacketed cable. Likewise, all sensors on the input loops are to be connected with 2-conductor 22 gauge cable. Cables must carry appropriate UL listing where applicable.

Table 2. 2520 Wiring/Testing Procedure

2520 CONTROL PANEL INSTALLATION	
1. Select a good location.	<p>Consider the following factors:</p> <ul style="list-style-type: none"> - Lack of temperature extremes and freedom from moisture. - Accessibility to "main drop" wiring runs. - Mounting surface (use of plywood interface when mounting on concrete). - Location well within secured area. - Customer accessibility for testing and resetting.
2. Mount the 2520.	<ul style="list-style-type: none"> a. Mounting on interior walls. When mounting on interior walls, use appropriate screw anchors in plaster. b. Mounting on concrete. When mounting on concrete, especially when moisture is expected, attach a piece of 3/4 inch plywood to the concrete surface and then attach the 2520. c. Mount any other desired components (such as optional power sources, terminal strips, 7150, etc.) to the plywood interface. d. Mount the 2520 in a location not subjected to high temperatures. Temperatures above 100°F adversely affect the 6812 battery.
3. Turn off the DC power switch.	
4. Mount the transformer (Model 9220, 16.5 VAC 60 Hz, 40 VA).	<ul style="list-style-type: none"> a. Wire the transformer to terminals 1 and 2 on the 2520 control panel (all references to "terminals" in these

Table 2. 2520 Wiring/Testing Procedure (Cont.)

2520 CONTROL PANEL INSTALLATION	
<p>4. Continued</p> <p>For lightning protection, connect the 7890 Lightning Kit following the specific instructions provided with the kit.</p>	<p>procedures refer to terminal screw posts on the 2520 control panel). Use 18 ga. or larger shielded wire, ground the shield as shown in Figure 10. (SK #9021 is recommended.)</p> <p>b. Screw out the screw on the faceplate of a wall outlet, plug in the transformer, and fasten the transformer to the outlet using the screw provided.</p>
<p>5. Attach jumper wires if not already installed.</p>	<p>The control panel was shipped without jumper wires installed, the following terminals must be jumped together, with a piece of insulated wire, in order to test the system: Terminal 7 to 8 and terminal 9 to 10.</p>
<p>6. Connect a resistor between terminal 4 and 6.</p>	<p>If not already connected, attach a Model 7630, 15,000 ohm. resistor (brown, green, orange) between terminals 4 and 6.</p>
<p>7. Connect a 6812 battery.</p> <div style="border: 1px solid black; padding: 5px; margin-top: 10px;"> <p>CAUTION: Observe polarity of the battery.</p> </div>	<p>a. Connect 6812 battery to battery cables.</p> <p>STOP: Observe battery polarity. Red to plus (+); Black to minus (-).</p> <p>b. If the transformer is connected, the battery will charge automatically with the DC power switch on or off.</p>
7331 DIGITAL KEY MODULE INSTALLATION (Figure 9)	
<p>1. Install the 7331 Key Module(s).</p>	<p>Installation Requirements: One 8 or 10-conductor cable is required to wire each 7331 to the 2520 control panel (10 conductor if speaker is used on 7331). Each 7331 requires 42 ma of current.</p> <p>Connect each 7331 to the 2520 as follows:</p>

Table 2. 2520 Wiring/Testing Procedures (Cont.)

7331 DIGITAL KEY MODULE INSTALLATION (Continued)	
<p>1. Install the 7331 Key Module(s) Continued.</p>	<p><u>Installation Requirements:</u> Continued</p> <ul style="list-style-type: none"> - Orange Wire to terminal 4 - Black Wire to terminal 18 - Brown Wire to terminal 11 - Yellow Wire to terminal 20 - Red Wire to terminal 19 - Purple Wire to terminal 16 - Green Wire to terminal 12 - Blue Wire to terminal 13 - White Wire to terminal 14
<p>FIELD TEST (2520 and 7331)</p>	
<p><u>2520 Control Panel Test</u></p> <p><u>Programming</u></p> <p>1. Check that the loop jumpers and 15K resistor are in place.</p>	
<p>2. Switch the DC power switch "On".</p>	<p>Ready light on 7331 begins blinking.</p>
<p>3. You now have approximately one minute to program the Arming/Disarming codes. If you do not enter these codes, the 2520 will automatically program itself to a default code of a digit (5) for arming and digits 1-2-3-4 for disarming. The 2520 will also attempt to Arm itself at this time. If it cannot Arm because an input is active, it will immediately go into an Intrusion alarm. To program the Arm and Disarm codes proceed as follows:</p>	<p>Each time a digit is pressed the speaker will emit a momentary tone.</p> <p>NOTE: The Arming digit may be used in the Disarm code, but not twice in sequence.</p>

Table 2. 2520 Wiring/Testing Procedures (Cont.)

FIELD TEST (2520 and 7331) (Cont.)	
<p><u>2520 Control Panel Test (Cont.)</u></p> <p>a. Go to the 7331 and press the digit desired for Arming (press once only).</p> <p>b. Press, in order, the four digits to be used for Disarming.</p>	<p>Ready light stops blinking, CODES are entered.</p>
<p><u>7331 Digital Key Module Test</u></p>	
<p>1. Enter the ARM Code. (Press arming digit twice.)</p>	<p>The system-armed light on all 7331 key modules should light.</p>
<p>2. Open the jumper between terminals 7 and 8.</p>	<p>The system should go into an immediate intrusion alarm as follows:</p> <ul style="list-style-type: none"> - All speakers sound an alarm tone, as does the speaker built into the 7331.
<p>3. Re-attach the jumper between terminals 7 and 8.</p>	
<p>4. Enter the DISARM Code.</p>	<p>The alarm resets and the system armed light of the 7331 goes off.</p>
<p>5. Repeat this test for each 7331 in the system.</p>	
<p>INTRUSION CIRCUIT INSTALLATION</p>	
<p>1. Install all normally-open and normally-closed instant circuit sensors (see Figure 3).</p>	<p>a. Disarm the system.</p> <p>b. If using normally-closed sensors in the instant circuit, remove the jumper from between terminals 7 and 8.</p>

Table 2. 2520 Wiring/Testing Procedure (Cont.)

INTRUSION CIRCUIT INSTALLATION (Cont.)	
1. Install instant circuit sensors continued.	<ul style="list-style-type: none"> c. Connect the normally-closed sensor loop to terminals 7 and 8. d. Connect the normally-open exterior circuit sensors to terminals 8 and 18.
2. Install all exit/entrance circuit sensors. (See Figure 4).	<ul style="list-style-type: none"> a. If using normally-closed exit/entrance circuit sensors, remove the jumper from between terminals 9 and 10 and connect the sensors to terminals 9 and 10. b. Connect all normally-open exit/entrance sensors to terminals 10 and 18.
3. Install fire bell (optional). Bell or external speakers may be used but <u>not both</u> .	<ul style="list-style-type: none"> a. Place option switch 10 in the CLOSED position. (If a bell is to be used.) b. Connect fire bell (12 volt bells only) to terminals 3 and 17. c. Connect a .22 MFD/100V capacitor across the bell points to suppress any feed-back noise that could influence the speaker or key circuits.
4. Install all external speakers.	<ul style="list-style-type: none"> a. Place option switch 10 in the OPEN position. b. Connect all speakers to terminals 3 and 17.
5. Turn ON DC Power switch.	
FIELD TEST (INTRUSION CIRCUIT)	
1. Go to a 7331 location. Enter ARM and DISARM codes.	<ul style="list-style-type: none"> a. The Ready light should be blinking.

Table 2. 2520 Wiring/Testing Procedure (Cont.)

FIELD TEST (INTRUSION CIRCUIT) (Cont.)	
<p>2. ARM the system. NOTE: If the Ready light is not on, the instant intrusion circuit or the exit/entrance circuit is faulty. Re-check all sensors for proper closing. To isolate a problem, disconnect the suspected circuit from the 2520 control panel and replace it with a jumper. Continue this procedure until the problem circuit is isolated. Then recheck the wiring, sensors, and attachments until the problem circuit is corrected. <u>Do not proceed with the rest of this test until a properly closed instant circuit is obtained.</u></p>	<p>a. The System Armed light should light. b. The Ready light should go off.</p>
<p>3. DISARM the system.</p>	<p>The system disarms.</p>
<p>4. To test individual sensors, open a door or window in the instant circuit and leave it open.</p>	
<p>5. Enter the ARM code.</p>	<p>The system should <u>not</u> arm.</p>
<p>6. Close the door or window.</p>	
<p>7. Repeat this test using different doors and windows until all instant loop sensors are checked.</p>	
<p>8. Reset all sensors to the armed position.</p>	
<p>9. ARM the system.</p>	<p>All system-armed lights should light.</p>

Table 2. 2520 Wiring/Testing Procedure (Cont.)

FIELD TEST (INTRUSION CIRCUIT) (Cont.)	
10. Open one of the sensed doors. The system should go into an Intrusion alarm.	a. All built-in speakers on the 7331's emit an alarm tone. b. All external speakers and bells emit a continuous alarm tone. c. The system-armed light flashes.
11. Enter the DISARM Code.	The alarm shuts off.
<u>Exit/Entrance Delay Test</u>	
1. ARM the system.	
2. Open and close a door in the exit/entrance loop and wait until the exit delay time expires.	The system should <u>not</u> go into Intrusion alarm.
3. DISARM the system.	
4. Repeat the test for each door in the exit/entrance loop.	
5. ARM the system.	
6. Open a door in the loop and leave it open.	
7. After the delay time expires (time selected for Option Switches 2 and 3) the Intrusion alarm should sound.	An Intrusion alarm occurs, all system speakers and bells emit an alarm and the system-armed light flashes.
8. DISARM the system.	The system disarms.

Table 2. 2520 Wiring/Testing Procedure (Cont.)

FIELD TEST (INTRUSION CIRCUIT) (Cont.)

9. ARM the system and wait until the exit delay time elapses.	
10. Open a door in the loop.	The exit/entrance tone should sound.
11. Let the exit/entrance tone sound until the exit/entrance delay again elapses.	An intrusion alarm should sound.
12. Repeat step 11, but DISARM the system while the exit/entrance tone is still sounding.	The exit/entrance tone should shut-off and no Intrusion alarm should sound.

FIRE CIRCUIT INSTALLATION (See Figure 7)

General Fire Circuit Information: Fire circuit wiring consists of a pair of wires connecting terminals 4 and 6 of the 2520 with all fire circuit devices, and ending with an end-of-line resistor (see Figure 7). Any interruption of this current produces a trouble signal. Problems that can cause current interruption are: faulty fire circuit wiring, faulty detector connections and faulty smoke detector operation. It is important, therefore, that the fire loop pair be brought to and from each device, and that the loop characteristic be maintained in order to provide maximum supervision. This means that a fire detector located a distance from a main wiring run requires four conductors (2 out, 2 back). A smoke detector requires the same wiring (supervisory contacts in series with the fire loop, alarm contacts in parallel) plus the addition of two conductors to supply power that may be "dead-ended".

A short across the wires of the fire circuit (as in the case of a heat detector activating) produces a fire alarm.

CAUTION: Early warning fire detection is best achieved by the installation of fire detection equipment in all rooms and areas of the household as follows:

A smoke detector installed in each separate sleeping area (the vicinity of, but outside of the bedrooms), and heat or smoke detectors in living rooms, dining rooms, bedrooms, kitchens, hallways, attics, furnace rooms, closets, utility and storage rooms, basements, and attached garages.

FIRE CIRCUIT INSTALLATION (See Figure 7) (Cont.)

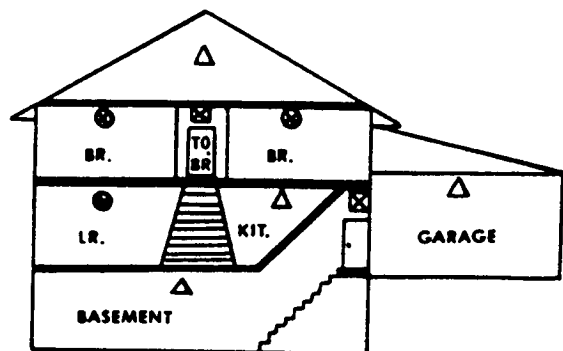

- Smoke detectors for minimum protection
- ⊗ Smoke detectors for additional protection
- △ Heat activated detectors

Typical installation layout of a Fire Security System.

IMPORTANT: Rate-of-rise sensors should be installed in areas of even temperature as they respond to temperature increases of 15°F, or greater, per minute. (Refer to Standard for Household Fire Warning Equipment, NFPA No. 74-1972.)

1. Install all normally-open fire sensors. (See Figure 7).

- a. Connect all sensors, including the 7610 smoke sensors, in a single parallel circuit with a 15,000 ohm resistor connected across the last sensor. (Use the resistor shipped with the system, which was connected to terminals 4 and 6 during the initial system tests.) Refer to Figure 7 throughout this procedure.
- b. Wire any fire-stats and smoke detectors so that the supervisory leads are connected in the series with the fire loop and the alarm leads are connected in parallel.
- c. 7610 Smoke Detector Installation Requirements: At least a 3-conductor cable is needed to wire each 7610 to the fire loop and power supply. Each 7610 requires 5 ma of current.

Table 2. 2520 Wiring/Testing Procedure (Cont.)

FIRE CIRCUIT INSTALLATION (See Figure 7) Cont.)

1. Install all normally-open fire sensors, Figure 7 (Cont.).

Connect each 7610 as follows:

- Red and one Purple Wire to terminal 4.
- Black Wire to terminal 18.
- Connect the remaining Purple Wire to the next Smoke or Heat detector, or if it is the last sensor in the fire loop, connect it to terminal 6.

d. Connect this entire circuit to terminals 4 and 6. NOTE: If the system does not include a fire circuit, leave the 15,000 ohm resistor between terminals 4 and 6.

FIELD TEST (TROUBLE SIGNAL, 7610)

Trouble Signal (Fire Loop) Test

1. Remove one of the wires from the 7630 end-of-line resistor.

- a. A trouble alert signal (steady, but less loud than an alarm tone).
- b. The monitor light on the 2520 should go off.

2. Move the monitor speaker switch on the 2520 to OFF.

- a. The alert tone should stop.
- b. The "Alert Silenced" light should come on.

3. Re-connect the wire to the sensor and restore the monitor speaker switch to ON.

- a. The monitor light should come back on.
- b. The "Alert Silenced" light should then go off.

7610 Smoke Detector Test

1. Hold the smoldering end of a piece of cotton rope, or a

After 20 to 25 seconds, a fire alarm should sound as follows:

Table 2. 2520 Wiring/Testing Procedure (Cont.)

FIELD TEST (TROUBLE SIGNAL, 7610) (Cont.)	
1. cigarette, three inches from the 7610 and allow the smoke to flow into the detector.	- All built-in speakers, all external speakers, or the bell in the system should sound an alarm tone.
2. Clear the smoke detector by fanning fresh air into it for 20 to 25 seconds.	
3. Since the 7610 is a latching alarm device, you must reset it manually by pressing the Fire reset/test switch on the 2520 control.	Both the 7610 and the 2520 control panel will be reset. All alarm conditions shut-down.
4. Repeat this test for all 7610's.	
5. Go back to the 2520. Press the red Fire test switch and hold.	<p>a. The system should go into a fire alarm as follows:</p> <ul style="list-style-type: none"> - The speaker in the 7331 sounds a Fire alarm. <p>b. <u>Weak battery:</u> If the fire alarm sounds for only a few seconds and then fades out, the 6812 battery is weak. Either replace the battery, or allow it to charge longer.</p>
6. Turn off the alarm by releasing the fire test switch.	The alarm turns off, and the channel resets.
7. Turn OFF DC power switch to reset Digital Dialer.	
PANIC/TAMPER/EMERGENCY CIRCUIT INSTALLATION	
1. Install all normally-closed	See Figure 6.

Table 2. 2520 Wiring/Testing Procedure (Cont.)

PANIC/TAMPER/EMERGENCY CIRCUIT INSTALLATION (Cont.)	
1. panic/tamper alarms. NOTE: Panic/tamper alarms active intrusion alarms whether or not the intrusion circuit is armed.	
2. Install all normally-open panic/ tamper circuit sensors.	See Figure 6.
3. Install all normally-open emer- gency circuit sensors.	See Figure 8.
FIELD TEST (PANIC/TAMPER/EMERGENCY CIRCUIT)	
<u>Panic/Tamper Input Test</u>	
1. Attempt to violate the system by removing a panic/tamper-moni- tored device from the wall where it is mounted.	An Intrusion alarm should sound.
2. Return the sensor to it original armed position.	
3. DISARM the system.	The alarm should shut off.
4. Repeat this test for each sensor in the panic/tamper loop.	
<u>Emergency Input Test</u>	
1. Jumper the contacts of the emer- gency sensor.	An Emergency alarm should sound.
2. DISARM the system.	The alarm should shut off.

Table 2. 2520 Wiring/Testing Procedure (Cont.)

FIELD TEST (Digital Dialer)	
<u>Digital Dialer Test</u>	
1. Notify the central message receiving point that you are making a test.	NOTE: Whenever the 2520 is reporting, the Ready light will be blinking on the 7331 or 7230. When the 2520 has received "Kiss-off", the Ready light will be on steady, or off entirely.
2. Perform a test on each system component as described earlier. Allow the alarm to sound until the Ready light stops blinking.	An appropriate alarm should sound for the type of test performed (specifically: fire, intrusion or emergency.)
3. Shut OFF the alarm.	
4. Call the central message receiving point for results of the test.	
<u>Opening/Closing Test</u>	
1. Place switch option (5) in the open position.	
2. Arm the intrusion circuit and wait until the ready light stops blinking.	The 2520 transmits a closing message to the central message receiving station (Code 4).
3. Cause an intrusion alarm and wait 45 seconds before disarming the system.	The 2520 transmits an intrusion alarm (Code 1).
4. Disarm the system and wait until the Ready light stops blinking.	The 2520 transmits an opening message to the central message receiving station (Code 9).

Table 2. 2520 Wiring/Testing Procedure (Cont.)

FIELD TEST (Fire Reset/Test Switch)	
<p>1. Press and HOLD for a minimum of 10 seconds, the Fire Reset/Test Switch.</p>	<p>Fire alarm should sound at all built-in and external speakers (or bell).</p> <p>NOTE: The Fire Reset/Test Switch disconnects the AC portion of the 2520's power supply in order to test the battery. If the Fire alarm does not come on when the switch is pressed this indicates that the battery is either not connected, not charged or is defective.</p>
<p>2. Release the Fire Reset/Test Switch.</p>	<p>Fire alarm will turn off. Digital Dialer will begin dialing to report a test code. This will be indicated by the Ready light which should be flashing on and off. When the receipt of message (Kiss-off) is received from the central message station the Ready light stops flashing and will be on steady.</p>
FIELD TEST (AUTOMATIC ATTEMPT-TO-RESET/AUTOMATIC SHUTDOWN)	
<p><u>Automatic Attempt-To-Reset</u></p> <p>1. Disable the bell and speakers except on the 7331, by temporarily removing connections from terminal 17.</p>	
<p>2. ARM the system.</p>	
<p>3. Open and then close a door in the intrusion loop.</p>	<p>An intrusion alarm should sound.</p>
<p>4. Wait 5 or 15 minutes (depending on position of Option Switch 8).</p>	<p>The alarm should shut-off. The system-armed light should remain on but will be blinking.</p>

Table 2. 2520 Wiring/Testing Procedure (Cont.)

**FIELD TEST
(AUTOMATIC ATTEMPT-TO-RESET/AUTOMATIC SHUTDOWN)**

5. DISARM the system.	The System-Armed light turns off.
<u>Automatic Shut-Down</u>	
1. ARM the system.	
2. Open a door in the Instant loop and leave it open.	An Intrusion alarm should sound.
3. Let the Intrusion alarm sound for 5 or 15 minutes (depending on Option Switch 8). At that time the system should automatically shut-down the audible alarm only.	Audible alarm shuts off after 5 or 15 minutes of alarm. The System-Armed light will be blinking.
4. DISARM the system.	

TEST FREQUENCY

The installed 2520 should be tested periodically according to the following schedule:

- Fire Weekly
- Intrusion Monthly
- Emergency Monthly
- Heat and Smoke Detectors Every 6 Months
- Attempt-To-Reset and
- Attempt-To-Shut-Down Annually

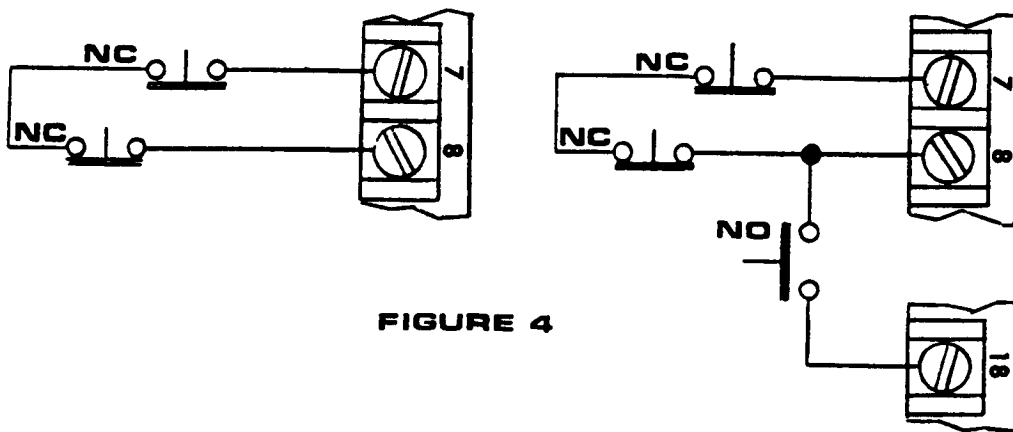

FIGURE 4

INTRUSION CIRCUITS

Note: If only normally-open sensors are used, a jumper must be connected across Terminals 7 and 8.

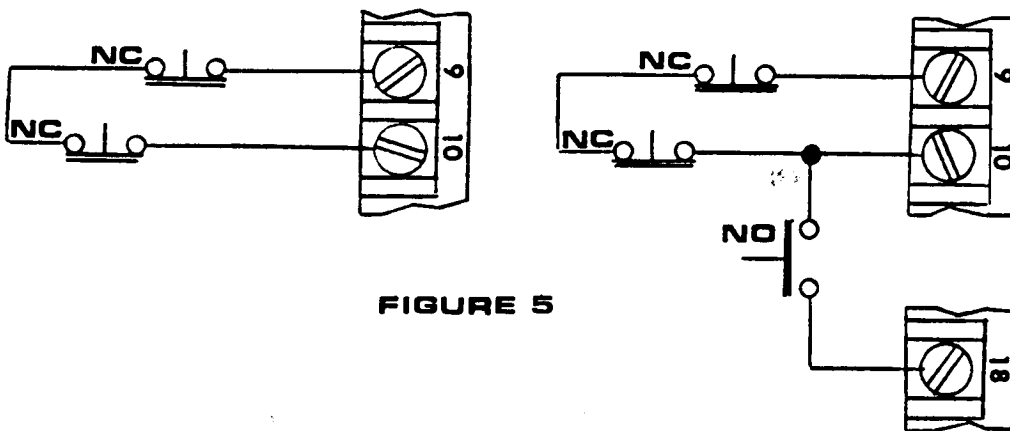
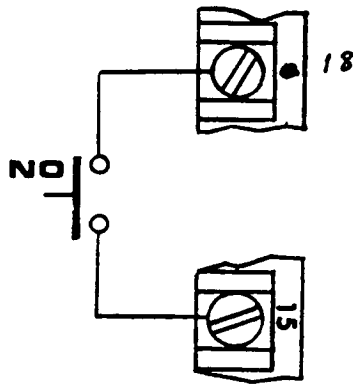

FIGURE 5

EXIT/ENTRANCE CIRCUITS

Note: If only normally-open sensors are used, a jumper must be connected across Terminals 9 and 10.

PANIC/TAMPER CIRCUITS



Note: Normally-open *only*.

FIGURE 6

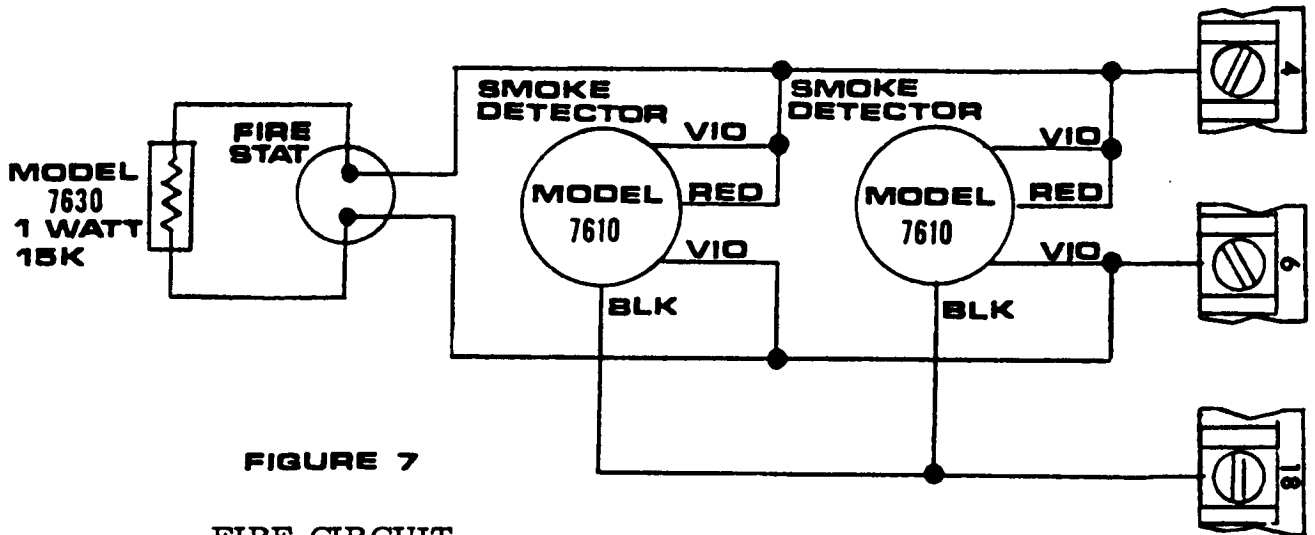
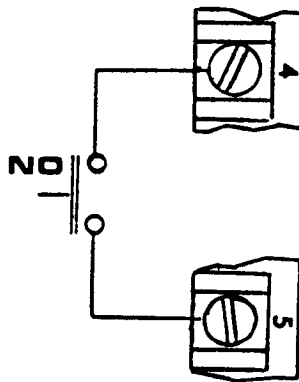

FIGURE 7

FIRE CIRCUIT

EMERGENCY CIRCUITS



Note: Normally-open *only*.

FIGURE 8

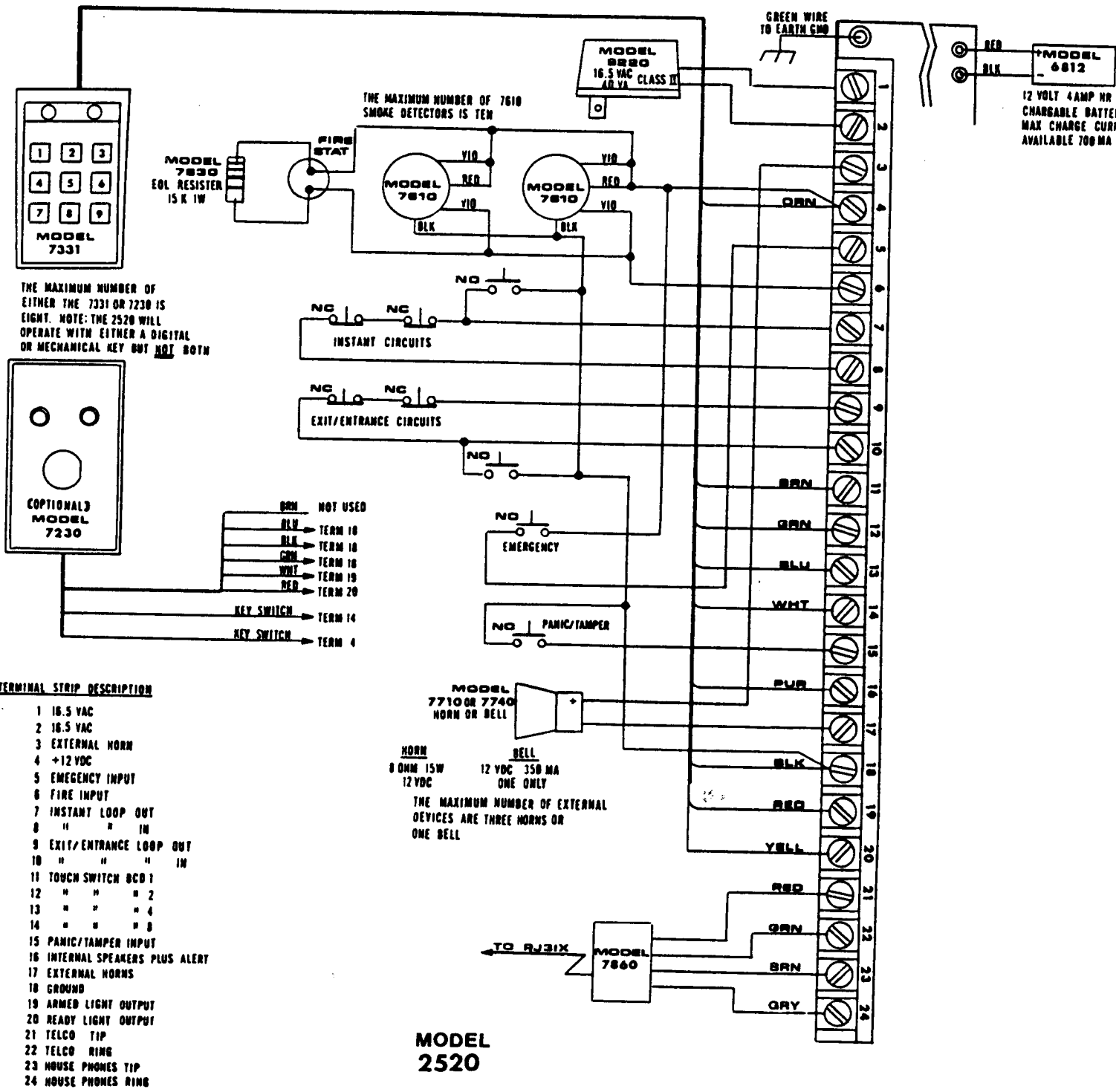

Figure 9

INSTRUCTION SHEET

MODEL 7890 TRANSIENT-SURGE PROTECTOR

The Model 7890 Protector, when properly installed with shielded two-conductor cable, will clamp the AC output of the Class II transformer (Model 9220) of the Silent Knight control panels. It reduces transient voltages frequently present on the power lines - caused by lightning and other sources - to manageable levels.

The AC power lines are the most common source of transient/lightning damage in alarm systems.

The Model 7890 consists of two bi-polar transient suppressors with lugs at it's connecting points.

CAUTION: Before connecting, verify that the center counting screw in the AC wall plate, to which the transformer is to be connected, is grounded to earth ground. This can be checked by measuring the AC voltage between the mounting screw and each side of the outlet. There must be an identical voltage between one side of the outlet to the screw and from one side of the outlet to the other -- approximately 117 VAC.

If these voltages are not identical the outlet does not have an earth ground and must be grounded by running a #18 conductor from the outlet to a good ground; for example, a cold water pipe.

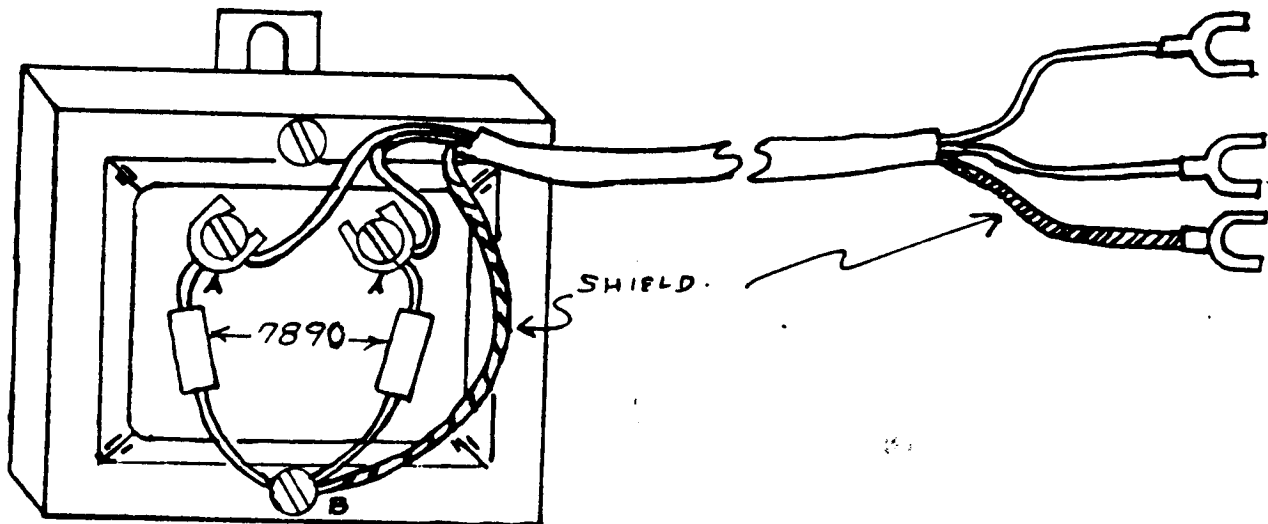

WIRING

1) With the transformer un-plugged, connect the open ends (A) of the 7890 to the two AC screws of the transformer. Connect the common end (B) of the 7890 to the screw containing the case assembly of the transformer.

2) Connect the shielded cable as shown; the black and white wires to the AC output screws and the shield to the screw holding the case assembly.

CAUTION! BE SURE THE SHIELD CONDUCTOR CAN NOT COME IN CONTACT WITH THE AC OUTPUT SCREWS.

3) Connect the other end of the shielded cable to the control panel; the black and white wires to the AC input, and the shield to the earth ground. (the same point as the green ground wire in the panel).

4) Plug in the transformer and securely fasten the mounting tab to the center mounting screw on the AC cover.

IMPORTANT. DO NOT USE THE 7890 TELEPHONE LINE CIRCUITS IN PLACE OF THE 7870. (OR VISA VERSA)
SHORT CIRCUIT WILL RESULT.